

📍 Outdoor installation  
for Tendina system only.

## DRAPERIES RANGE

Draperies bring elegance and harmony to any space. They are a great choice for large windows and can be adapted to both straight and curved surfaces. A system that offers the possibility of manual, cord or motor operation systems and various customization options.



### PROFILE COLORS AVAILABLE

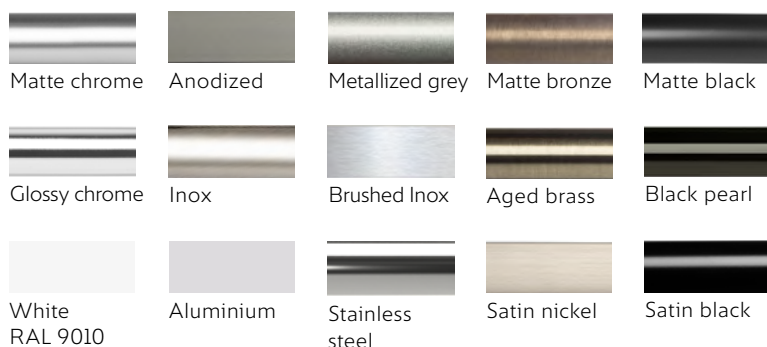

### OPERATING SYSTEMS



MAXIMUM WIDTH  
**6000 mm** x 4000 mm

MAXIMUM HEIGHT  
4800 mm x **5000 mm**

# DRAPERIES RANGE

## PRODUCT PRESENTATION

---

### Types of tailoring

Several types of manufacture are available:



**Grommets**



**Normal Pleat**



**Flat Pleat**



**Table Pleat**



**Single Pleat**



**V Pleat**

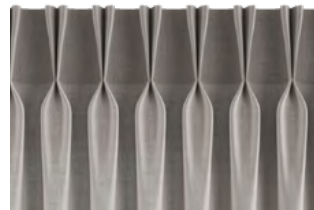

**Double Pleat**

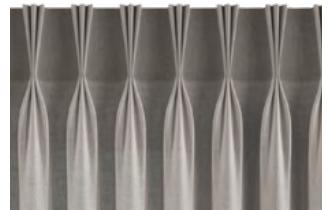

**Triple Pleat**



**Ripple Fold**

---

### Draperies length options

The latest trend is to let draperies puddle on the floor. Choose the option that matches perfectly with your style: Floor, Break and Puddle.



**Floor**



**Break**



**Puddle**

---

### Acoustic absorption to improve the indoor environment

MOVES collection includes fabrics that improve the indoor environment thanks to their acoustic absorption properties. This performance is enhanced thanks to the wave geometry that the fabrics adopt once they are made.

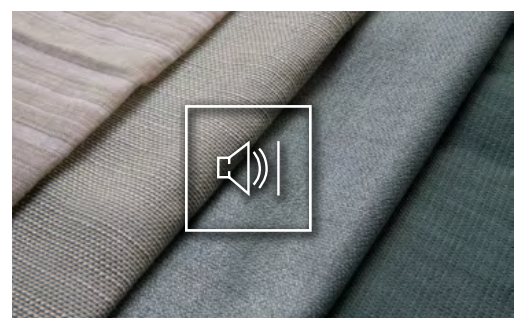

# DRAPERIES RANGE

## PRODUCT PRESENTATION

### Combination with other systems

Draperies can be combined with other Bandalux systems: roller shades, venetian blinds, pleated blinds, neolux, roman shades...



### Silent and High-Performance Motorization

Bandalux motorized tracks offer a silent and powerful motorization option for traditional curtains. The motor is activated automatically by pulling the curtain fabric, using a remote control, or a wall switch. It can be installed on either side of the track, and the curtain fabric is designed to conceal the motor from view (max. surface area: 24 m<sup>2</sup>). The track can be curved for spaces with curved walls or used as a room divider.

Up to three types of motorized tracks are available: Estrada track, XXL\* track, and GLYDEA\* track.

\* Compatible with Lynx and other home automation systems.



### Wide range of finishes for bars and rails

 [Click here to see all the bars and track models in detail](#)



Matte chrome

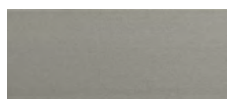

Anodized



Metallized grey



Matte bronze



Matte black



Glossy chrome



Inox



Brushed Inox



Aged brass



Black pearl

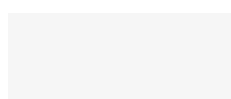

White RAL 9010

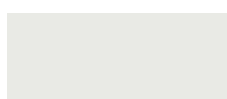

Aluminium



Stainless steel

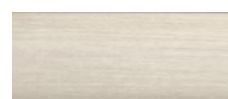

Satin nickel





Satin black

# DRAPERIES RANGE

## PRODUCT PRESENTATION





### Bar range

A selection of top-quality rods that follow the latest trends in decoration and allow the curtain to be used manually. Three categories to choose from: Supreme, Luxe and Elite. Front or ceiling installation.

	ELITE SERIES		
	Sheba bar	Ophra bar	Vania bar
			
Maximum width (WxH)	5000 x 3000 mm	5000 x 3000 mm	5000 x 3000 mm
Maximum height (WxH)	5000 x 3000 mm	5000 x 3000 mm	5000 x 3000 mm
Bar colors	Matte chrome	Aged brass	Glossy chrome
Material	Painted steel	Painted steel	Painted steel
Diameter	ø 28 mm	ø 28 mm	ø 28 mm
Operating system	Manual	Manual	Manual
Visible bar / Hidden bar	Grommets : hidden bar Rings : visible bar	Grommets : hidden bar Rings : visible bar	Grommets : hidden bar Rings : visible bar
Manufactures	Grommets Normal Pleat Flat Pleat Table Pleat Single Pleat V Pleat Double Pleat Triple Pleat	Grommets Normal Pleat Flat Pleat Table Pleat Single Pleat V Pleat Double Pleat Triple Pleat	Grommets Normal Pleat Flat Pleat Table Pleat Single Pleat V Pleat Double Pleat Triple Pleat
Options	Double fabric		

# DRAPERIES RANGE

## PRODUCT PRESENTATION

ELITE SERIES	LUXE SERIES	SUPREME SERIES	
Safira bar	Tendina bar	Celes bar	Amarant bar
			
5000 x 3000 mm	5000 x 3000 mm	5000 x 3000 mm	5000 x 3000 mm
5000 x <b>3000</b> mm	5000 x <b>3000</b> mm	5000 x <b>3000</b> mm	5000 x <b>3000</b> mm
Black pearl	Stainless steel	Matte bronze	Matte black
Painted steel	Stainless steel (Ideal for outdoor)	Bar : aluminium End caps and brackets : solid aluminium	Bar : brass End caps and brackets : solid brass
ø 28 mm	ø 28 mm	ø 28 mm	ø 28 mm
Manual	Manual	Manual	Manual
Grommets : hidden bar Rings : visible bar	Grommets : hidden bar	Grommets : hidden bar Rings : visible bar	Grommets : hidden bar Rings : visible bar
Grommets Normal Pleat Flat Pleat Table Pleat Single Pleat V Pleat Double Pleat Triple Pleat	Grommets	Grommets Normal Pleat Flat Pleat Table Pleat Single Pleat V Pleat Double Pleat Triple Pleat	Grommets Normal Pleat Flat Pleat Table Pleat Single Pleat V Pleat Double Pleat Triple Pleat
Double fabric			

# DRAPERIES RANGE

## PRODUCT PRESENTATION

### Tracks range







A selection of top-quality tracks in line with current design trends. Different operating system: manual, wand, cord or motor. Three categories to choose from: Supreme, Luxe and Elite. Front or ceiling installation. Depending on the type of track chosen, it can be visible or hidden by the fabric.



Maximum width (WxH)	5000 x 3000 mm	6000 x 3000 mm	5000 x 3000 mm	5000 x 3000 mm	2500 x 3000 mm
Maximum height (WxH)	5000 x 3000 mm	6000 x 3000 mm	5000 x 3000 mm	5000 x 3000 mm	2500 x 3000 mm
Profile colors	White RAL 9010	White RAL 9010	Anodized	Satin nickel	Metallized grey Satin black
Material	Aluminium	Aluminium	Aluminium	Aluminium	Aluminium
Operating system	Manual, cord	Manual, wand cord	Manual, wand (Wand only available for Ripple Fold manufacture)	Manual	Manual
Visible track / Hidden track	Hidden	Visible	Visible	Visible	Visible
Decorative track	X	X	✓	✓	X
Manufactures	Normal Pleat Flat Pleat Table Pleat	Ripple Fold	Normal Pleat Flat Pleat Table Pleat Single Pleat V Pleat Double Pleat Triple Pleat Ripple Fold	Normal Pleat Flat Pleat Table Pleat Single Pleat V Pleat Double Pleat Triple Pleat	Normal Pleat Flat Pleat Table Pleat Single Pleat V Pleat Double Pleat Triple Pleat
Options	Double fabric				

# DRAPERIES RANGE

## PRODUCT PRESENTATION

LUXE SERIES			SUPREME SERIES	MOTOR SERIES		
Kali track	Elpis track	Yuna track	Aeris track	Estrada track	Glydea track	XXL track (only for Lynx)
						
5000 x 3000 mm	5000 x 3000 mm	5000 x 3000 mm	5000 x 3000 mm	6000 x 4000 mm	6000 x 3000 mm	6000 x 4000 mm
5000 x 3000 mm	5000 x 3000 mm	5000 x 3000 mm	5000 x 3000 mm	4800 x 5000 mm	3600 x 5000 mm	4800 x 5000 mm
Brushed Inox Satin black	Stainless steel Satin black	Satin nickel	Satin nickel Matte black	White RAL 9010	White	White RAL 9010 Aluminium
Anodized aluminium	Steel	Track : aluminium End caps and brackets: solid aluminium mechanised	Track : anodized aluminium End caps and brackets: solid aluminium mechanised	Aluminium		
Cord	Cord	Manual	Cord	Motor		
Visible	Visible	Visible	Visible	Hidden: Flat Pleat Table Pleat, Normal Pleat Visible: Ripple Fold		
✓	✓	✓	✓	✗		
Normal Pleat Flat Pleat Table Pleat Ripple Fold	Normal Pleat Flat Pleat Table Pleat Ripple Fold	Normal Pleat Flat Pleat Table Pleat Single Pleat <sup>(1)</sup> V Pleat <sup>(1)</sup> Double Pleat <sup>(1)</sup> Triple Pleat <sup>(1)</sup> Ripple Fold <sup>(1)</sup>	Normal Pleat Flat Pleat Table Pleat Ripple Fold	Normal Pleat Flat Pleat Table Pleat Ripple Fold		
Double fabric				Curved track Double fabric	Double fabric	Curved track Double fabric

❗ (1) Not compatible with 2-track Yuna track.



# DRAPERIES RANGE

## PRODUCT PRESENTATION

---

### Two fabrics in one shade

It is possible to combine two fabrics in the same draperies thanks to the double supported bar, double track or double supported track options.



### Trazer decorative cover

A modern and minimalist decorative cover to add a touch of class and sophistication. Available in white textured matte finish and anodized aluminum.



### Fabric matching components

All draperies components (yarns, ribbon, cord) are coordinated with the fabric color for a highly aesthetic visual effect.

### Double fabric to minimize the light passage

Minimizes excess backlight transparency and maintains draperies appearance at all times. Also available with blackout lining for maximum opacity.



### Also for outdoors

Polyscreen® 314 and Polyscreen® Silken Tendina draperies are the perfect choice for outdoor applications, as it provides resistance and requires very easy maintenance.

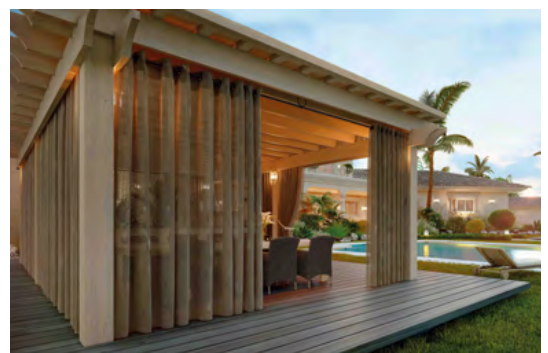



# DRAPERIES RANGE PRODUCT PRESENTATION

---

## Safety first

Bandalux prioritizes security and therefore supplies by default a child safety system that holds the cord or chain tight to the wall to prevent children from getting entangled in it.



PATENTED BY  
BANDALUX

### SafeKids

Patented by Bandalux.

Highly efficient security device that ensures the attachment of the cord or the chain to the wall. The shade can only be operated if the device is installed.

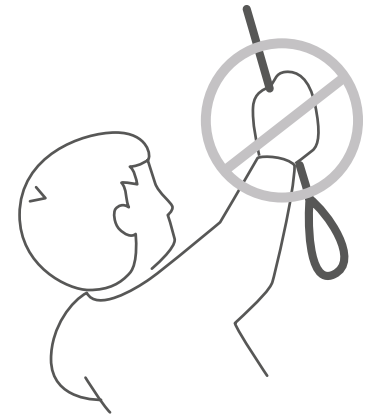

### Child Safety

Standard security device in the market that is served by default.

---

## Children can get tangled up with the shade/blind cord or chain

Always keep the chain or cord of the shades out of the reach of children. Since children can climb furniture, make sure to put the cribs, playpens or any furniture away from cords or chains.

The supplied safety device (see photo) must always be securely attached to the wall and hold tightly the cord or chain, thus preventing children from pulling them around the neck.

By default, Bandalux will always provide all shades and blinds with Child Safety System. When not necessary due to the absence of children, the waiver must be signed.

Bandalux will not be responsible for installation by third parties. It is the responsibility of the installer to correctly place the child safety system.

# DRAPERIES RANGE

## OPTIONS

### Type of manufacture

**Grommets**  
1,6 pleat served by default



**Normal Pleat**  
2 pleat served by default



**Flat Pleat**  
2 pleat served by default



**Table Pleat**  
2 pleat served by default



**Single Pleat**  
2 pleat served by default



**V Pleat**  
2 pleat served by default

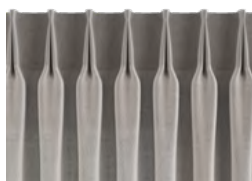

**Double Pleat**  
2 pleat served by default

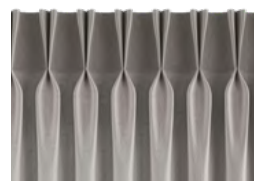

**Triple Pleat**  
2,5 pleat served by default



**Ripple Fold**  
1,8 pleat served by default

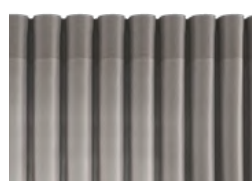

❶ Manufactured fabric only, does not include either the bar or the track. See bars on page 12. / The color of the grommets will be provided to match the fabric, at the discretion of Bandalux.

% of pleat	Pleat	Grommets	Normal Pleat	Flat Pleat	Table Pleat	Single Pleat	V Pleat	Double Pleat	Triple Pleat	Ripple Fold
60%	1,6	✓	✓	✓	-	-	-	-	-	✓
80%	1,8	-	✓	✓	-	-	-	-	-	✓
100%	2	-	✓	✓	✓	✓	✓	✓	-	✓
150%	2,5	-	✓	✓	-	-	-	-	✓	-
Compatible systems		Bars	Bars (with rings) Elementos track Square track (Manual) Urban track Dike track Kali track Elpis track Yuna track Aeris track Estrada track Glydea track XXL track				Bars (with rings) Square track (Manual) Urban track Dike track Yuna track (1 shade)			Ripple Fold track Square track Kali track Elpis track Yuna track (1 shade) Aeris track Estrada track Glydea track XXL track

❶ Indicate the pleat percentage on the order form. By default, Bandalux will provide the shade with a pleat, unless otherwise specified.

### Draperies length options

Bandalux offers several fabric fall options to choose the one that best suits your style:

#### Floor

Ground level, it is recommended to take 10 mm off from the draperies height

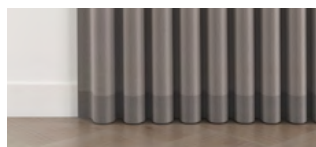

#### Break

It is recommended to add 100 mm to the draperies height.

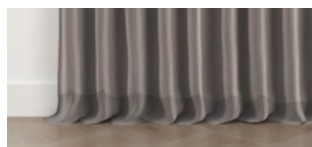

#### Puddle

It is recommended to add 250-300 mm to the draperies height.



❶ Please request and specify the draperies height according to the fabric fall in the order form.

# DRAPERIES RANGE



















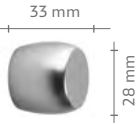
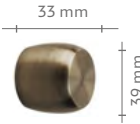
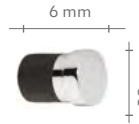

## OPTIONS

### Operating systems

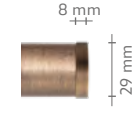
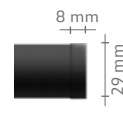
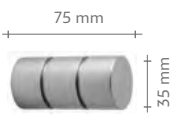
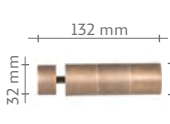
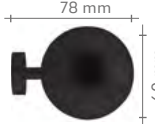
#### INDOOR BARS AND ACCESSORIES

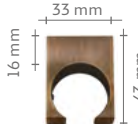
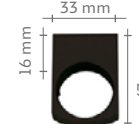
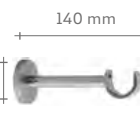
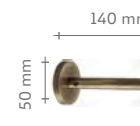
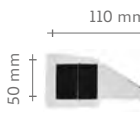
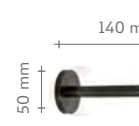
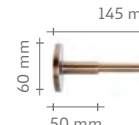
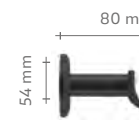

[Click here to see all the bars and track models in detail](#)

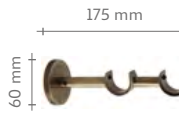
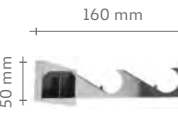
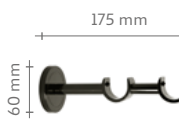
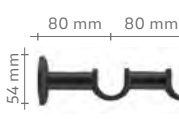
	<b>Sheba<sup>(1)</sup></b> Matte chrome	<b>Ophra<sup>(1)</sup></b> Aged brass	<b>Vania<sup>(1)</sup></b> Glossy chrome	<b>Safra<sup>(1)</sup></b> Black pearl	<b>Celes</b> Matte bronze	<b>Amarant</b> Matte black
<b>Ø28 mm bars<sup>(2)</sup></b>	 Ref. 18900003	 Ref. 18900004	 Ref. 18900002	 Ref. 18900001	 Ref. 18900006	 Ref. 18900007
<b>Rings<sup>(1)</sup></b>	 Ref. 18908003	 Ref. 18908004	 Ref. 18908002	 Ref. 18908001	 Ref. 18412400	 Ref. 18412410
<b>End caps</b>	 Ref. 18901803	 Ref. 18902004	 Ref. 18901502	 Ref. 18901501	 Ref. 18413400	 Ref. 18413500
	 Ref. 18901603	-	-	-	 Ref. 18413410	 Ref. 18413510
<b>Brackets</b>	 Ceiling Ref. 18905403	 Ceiling Ref. 18905404	 Ceiling Ref. 18905402	 Ceiling Ref. 18905401	 Ceiling Ref. 18414420 Compatible only with rings	 Ceiling Ref. 18414520 Compatible only with rings
	 Wall Ref. 18905103	 Wall Ref. 18905104	 Wall Ref. 18905102	 Wall Ref. 18905101	 Wall Ref. 18414400	 Wall Ref. 18414500
	 Double Ref. 18905303	 Double Ref. 18905304	 Double Ref. 18905302	 Double Ref. 18905301	-	 Double Ref. 18414510

ⓘ (1) For shades measuring 2500 mm or more, all bars will be provided in two sections, joined by a central screw that will be hidden behind the wall- or central ceiling-mounted bracket. / (2) Minimum order 1500 mm. Minimum size 500 mm. / (3) Rings compatible with all types of manufacture, except for Grommets and Ripple Fold. 10 rings will be provided by Bandalux for each meter.

# DRAPERIES RANGE











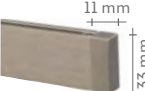

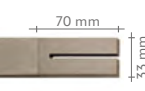



## OPTIONS

### Operating systems

MANUAL, CORD AND WAND TRACKS

 [Click here to see all the bars and track models in detail](#)

ELITE SERIES				LUXE SERIES		
Elementos <sup>(1)</sup> White RAL 9010	Ripple Fold <sup>(1)(4)</sup> White RAL 9010	Square <sup>(1)</sup> Anodized	Urban <sup>(1)</sup> Satin nickel	Dike <sup>(1)</sup> Metallized grey Satin Black	Kali <sup>(1)</sup> Brushed Inox Satin black	Elpis <sup>(1)</sup> Stainless steel Satin black
						





Operating systems	Manual	Ref. 18200008EM	Ref. 182000021M	Ref. 182000023	Ref. 182000022	Ref. 182000032	-	-
	Wand	-	Ref. 182000021	Ref. 182000024 <sup>(3)</sup>	-	-	-	-
	CORD <sup>(2)</sup>	Ref. 18200008E	Ref. 182000020	-	-	-	Ref. 182000030	Ref. 182000031
	Motor	-	-	-	-	-	-	-
End caps	Plug	Included		 Ref. 18050017	 Ref. 18050015	Included		
	Decorative			 Ref. 18050018	 Ref. 18050016			
Supports	Ceiling	Included		 Ref. 18414020	 Ref. 18414120	-	 Ref. 18414620 Stainless Steel Ref. 18414621 Black	 Ref. 18414640 Stainless steel Ref. 18414641 Black
	Wall			 Ref. 18414000	 Ref. 18414100	 Ref. 18414650 Grey Ref. 18414651 Black	 Ref. 18414600 Stainless Steel Ref. 18414601 Black	 Ref. 18414630 Stainless steel Ref. 18414631 Black
	Double front			 Ref. 18414010	 Ref. 18414110	 Ref. 18414660 Grey Ref. 18414661 Black	 Ref. 18414610 Stainless Steel Ref. 18414611 Black	 Ref. 18414635 Stainless steel Ref. 18414636 Black

① (1) Minimum order 2000 mm. / (2) See Child Safety system on page 17. / (3) Square track with wand only available for Ripple Fold manufacture. / (4) Ripple Fold adjoined at 4800 mm and larger sizes.



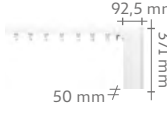

# DRAPERIES RANGE

## OPTIONS

 [Click here to see all the bars and track models in detail](#)

LUXE SERIES		SUPREME SERIES	MOTOR TRACK		
Yuna 1 shade <sup>(1)</sup> Satin nickel	Yuna 2 shades <sup>(1)</sup> Satin nickel	Aeris <sup>(1)</sup> Satin nickel Matte black	Estrada White RAL 9010	Glydea White	XXL (Lynx) White RAL 9010 Aluminium
					
Ref. 18200028 <b>216,30 €/m</b>	Ref. 18200029 <b>228,80 €/m</b>	-	-	-	-
-	-	-	-	-	-
-	-	Ref. 18200027 <b>379,60 €/m</b>	-	-	-
-	-	-	Ref. 18050220 Straight Ref. 18050221 Curved <b>Price motorized track page 30.</b>	Ref. 18050208 - 35 WT Ref. 18050212 - 60 WT Ref. 18050214 - 35 RTS Ref. 18050218 - 60 RTS <b>Price motorized track page 30.</b>	Ref. 18050200 Straight - White Ref. 18050203 Straight - Aluminium Ref. 18050201 Curved - White <b>Price motorized track page 30.</b>

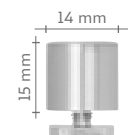
Included

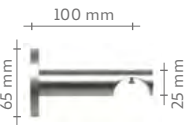
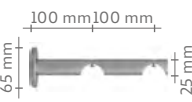
			Included		
Ref. 18414310	Ref. 18414310	Ref. 18414220 Nickel Ref. 18414221 Black			
			Included		
Ref. 18414300	Ref. 18414300	Ref. 18414200 Nickel Ref. 18414201 Black			
-	-		-	-	-
		Ref. 18414210 Nickel Ref. 18414211 Black			

# DRAPERIES RANGE

## OPTIONS

### Operating systems and child safety systems

#### WAND

1220 mm
1520 mm
1830 mm

① One wand for fabric



#### CORD

##### Child Safety



Served by default

##### SafeKids



#### Colors

- Black
- Brown
- White
- Ivory
- Grey

### MOTORIZED TRACK

#### Estrada

White RAL 9010



#### Applications

Normal Pleat  
Flat Pleat  
Table Pleat  
Ripple Fold

#### Automatizms

##### ESTRADA

Multi-channel remote control

**6 CHANNEL TRANSMITTER**  
Ref. 18531100

Wall-mounted single-channel inverter

**SINGLE CHANNEL WALL INVERTER**  
Ref. 18531200



#### Glydea

White



#### Applications

Normal Pleat  
Flat Pleat  
Table Pleat  
Ripple Fold

##### GLYDEA

Single-channel remote control

**SITUO 1 RTS PURE**  
Ref. 06700970D

Multi-channel remote control

**SITUO 5 RTS PURE**  
Ref. 06700881D



#### XXL (Lynx and other home automation systems on the market)

White RAL 9010, Aluminium



#### Aplicaciones

Normal Pleat  
Flat Pleat  
Table Pleat  
Ripple Fold

Measurements in mm

STRAIGHT TRACK	WIDTH W ▶	150	200	250	300	350	400	450	500	550	600
Estrada Ref. 18050220 - White											
Glydea - 35 WT Ref. 18050208 - White											
Glydea- 60 WT Ref. 18050212 - White											
Glydea - 35 RTS Ref. 18050214 - White											
Glydea - 60 RTS Ref. 18050218 - White											
XXL <sup>(1)</sup> Ref. 18050200 - White Ref. 18050203 - Aluminium											

① (1) XXL Track only available with the LYNX application and compatible with other home automation systems on the market.



# DRAPERIES RANGE OPTIONS

Measurements in mm

CURVED TRACK	WIDTH W ▶	150	200	250	300	350	400	450	500	550	600
Estrada <sup>(1)</sup> Ref. 18050221 - White											
XXL <sup>(1)</sup> Ref. 18050201 - White											

❶ (1) Not applicable to Ripple Fold. Requires a real-size template.

## Trazer pelmet

☐ Textured white    ■ Anodized aluminum



Trazer 73      Trazer 100

❶ Minimum order 1 m.

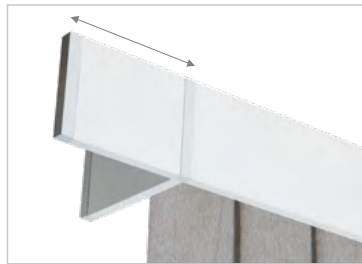

Projection

❶ Consult the technical data on page 23.

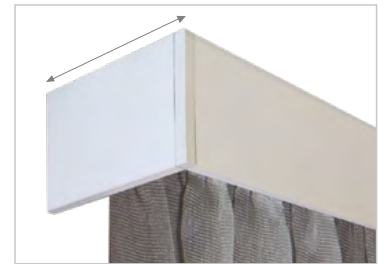

Mount plate

❶ For wall installation, the size of the mount plate must be 10 mm larger than the size of the bracket. / Consult the minimum and maximum measurements on page 23.

## REINFORCED EXTENSIBLE TRAZER BRACKETS



100-120 mm

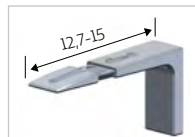

130-150 mm

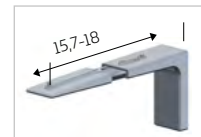

160-180 mm

❶ Indicate the size of the bracket on the order form. The size must be 10 mm smaller than the size of the mount plate. / By default, Bandalux will provide the brackets in the same color as that of the pelmet. If a different color is desired, please indicate so on the order form.

## Grommets

Old copper



Matt nickel brass



Black



The color of the grommets will be provided to match the fabric, at the discretion of Bandalux. If you would like a different colour, pleaseon the order form or in eBA.

## Other options



Double fabric

❶ Option only available for Normal Pleat and Ripple fold manufacturings.

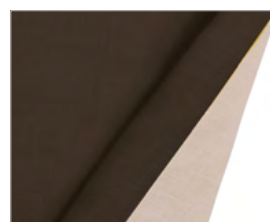

Double fabric  
with blackout lining

❶ Option only available for Normal Pleat and Ripple fold manufacturings.

Bandalux recommends this option for fabrics with the same composition and cleaning indications to avoid skrinkage incident.

# DRAPERIES RANGE

## OPTIONS

### Tendina for outdoors

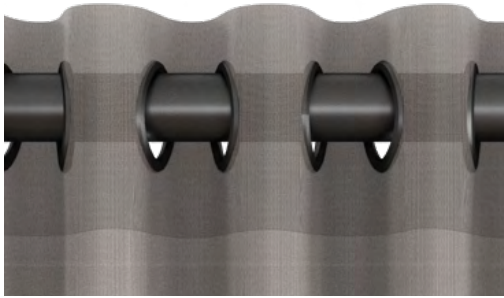

Fabric	Type	Largeur (mm)	Height limit (mm)
POLYSCREEN® 314	OF 14 %	2500	3000
POLYSCREEN® SILKEN	OF 14 %	2500	3000

OF: Openess factor.

#### FEATURES

Type of manufacturing: Grommets.

A shade manufactured with Polyscreen® 314 and Polyscreen® Silken fabric, which is made with highly resistant polyester thread and covered with lead-free PVC.

Highly resistant to the outdoor elements, with a 5-year warranty.

14 % opening setting, making for total visibility through the fabric.

Outdoor installation: ideal for pergolas, balconies, porches and similar structures. Grommets made of heat-resistant and water-resistant ABS material.

#### Reinforced side hems

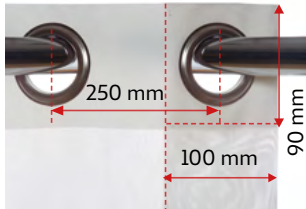

#### ABS grommet for outdoors



❶ The color of the grommets will be provided to match the fabric, at the discretion of Bandalux. If you would like a different colour, pleaseon the order form or in eBa.

### Bars and brackets for outdoor (optional)

**Stainless steel  
ø28 mm bar**  
(Weather resistant)  
18900300



**Inter-wall  
bracket**  
18900920



❶ Incompatible with bottom bar.

**Wall  
bracket**  
18900930



**Bottom bar**  
(Ceiling or wall installation)  
18900910



# DRAPERIES RANGE

## TECHNICAL DATA

### Minimum and maximum sizes

Model	Operating system	Shade width <sup>(2)</sup>		Shade height <sup>(1)</sup>		Surface	
		Minimum	Maximum	Minimum	Maximum	Minimum	Maximum
ø28 mm bar	Manual	400 mm	5000 mm	400 mm	3000 mm	0,16 m <sup>2</sup>	15 m <sup>2</sup>
Elementos track	Manual	400 mm	5000 mm	400 mm	3000 mm	0,16 m <sup>2</sup>	15 m <sup>2</sup>
	Cord	400 mm	5000 mm	400 mm	3000 mm	0,16 m <sup>2</sup>	15 m <sup>2</sup>
Ripple Fold track <sup>(3)</sup>	Manual	400 mm	6000 mm	400 mm	3000 mm	0,16 m <sup>2</sup>	18 m <sup>2</sup>
	Cord	400 mm	6000 mm	400 mm	3000 mm	0,16 m <sup>2</sup>	18 m <sup>2</sup>
	Wand	400 mm	6000 mm	400 mm	3000 mm	0,16 m <sup>2</sup>	18 m <sup>2</sup>
Square track	Manual	400 mm	5000 mm	400 mm	3000 mm	0,16 m <sup>2</sup>	15 m <sup>2</sup>
	Wand	400 mm	5000 mm	400 mm	3000 mm	0,16 m <sup>2</sup>	15 m <sup>2</sup>
Urban track	Manual	400 mm	5000 mm	400 mm	3000 mm	0,16 m <sup>2</sup>	15 m <sup>2</sup>
Dike track	Manual	400 mm	2500 mm	400 mm	3000 mm	0,16 m <sup>2</sup>	7,5 m <sup>2</sup>
Kali track	Cord	400 mm	5000 mm	400 mm	3000 mm	0,16 m <sup>2</sup>	15 m <sup>2</sup>
Elpis track	Cord	400 mm	5000 mm	400 mm	3000 mm	0,16 m <sup>2</sup>	15 m <sup>2</sup>
Yuna track	Manual	400 mm	5000 mm	400 mm	3000 mm	0,16 m <sup>2</sup>	15 m <sup>2</sup>
Aeris track	Cord	400 mm	5000 mm	400 mm	3000 mm	0,16 m <sup>2</sup>	15 m <sup>2</sup>
Estrada track	Motor	400 mm	6000 mm	400 mm	5000 mm	0,16 m <sup>2</sup>	24 m <sup>2</sup>
Glydea track	Motor	400 mm	6000 mm	400 mm	5000 mm	0,16 m <sup>2</sup>	24 m <sup>2</sup>
XXL track	Motor	400 mm	6000 mm	400 mm	5000 mm	0,16 m <sup>2</sup>	24 m <sup>2</sup>

❶ (1) The maximum shade height may vary, depending on the fabric used. / (2) To adapt the larger sizes to the width of the piece, the fabric will be stitched vertically, leaving the seam hidden amid the pleats of the shade. / (3) Ripple fold adjoined track at widths of 4800 mm and greater.

### Number of brackets according to shade width

ø28 mm bar <sup>(1)</sup> Tracks: Square / Urban / Yuna / Aeris	
Shade width (mm)	Nº brackets
W < 2000	2
2000 ≤ W < 5000	3

❶ (1) 10 rings will be provided by Bandalux for each meter.

Tracks: Elementos / Glydea / Estrada / Ripple Fold / XXL	
Shade width (mm)	Nº brackets
W < 1250	2
1250 ≤ W < 2000	3
2000 ≤ W < 3000	4
3000 ≤ W < 4000	5
4000 ≤ W < 5000	6
5000 ≤ W	7

Kali track	
Shade width (mm)	Nº brackets
W ≤ 1800	2
1800 < W ≤ 3800	3
3800 < W	5

Tracks: Elpis / Dike	
Shade width (mm)	Nº brackets
W ≤ 2200	2
2200 < W ≤ 4600	3
4600 < W	4

# DRAPERIES RANGE

## TECHNICAL DATA

### Hem measurements according to type of manufacture

Model	Grommets	Flat Pleat	Table Pleat	Normal Pleat	Single Pleat	V Pleat	Double Pleat	Triple Pleat	Ripple Fold
Top hem	90 mm	75 mm	75 mm	75 mm	100 mm	100 mm	100 mm	100 mm	75 mm
Side hem	15 mm	40 mm	40 mm	40 mm	40 mm	40 mm	40 mm	40 mm	40 mm
Bottom hem	120 mm	120 mm	120 mm	120 mm	120 mm	120 mm	120 mm	120 mm	120 mm

### Stacking types

#### Manual track

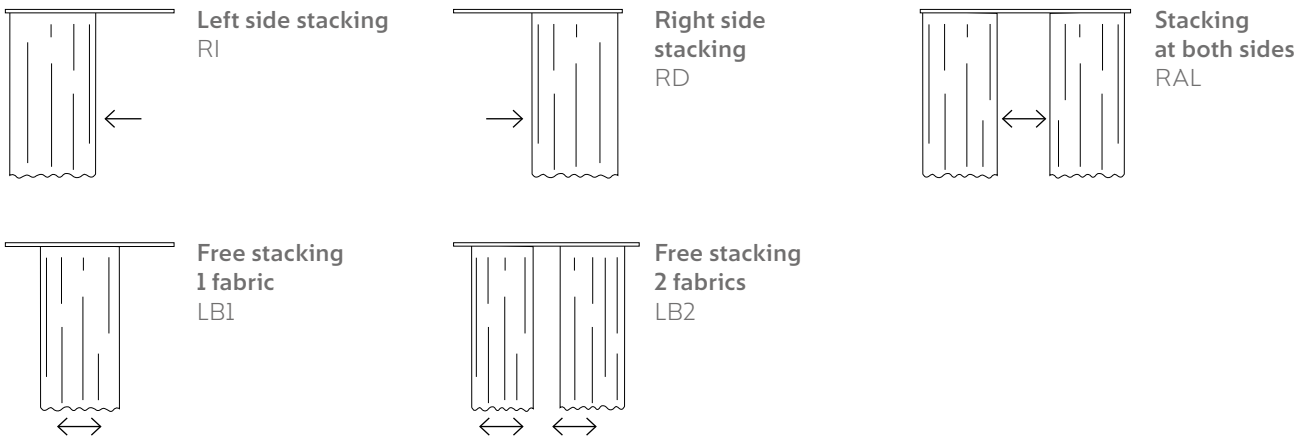

#### Wand track

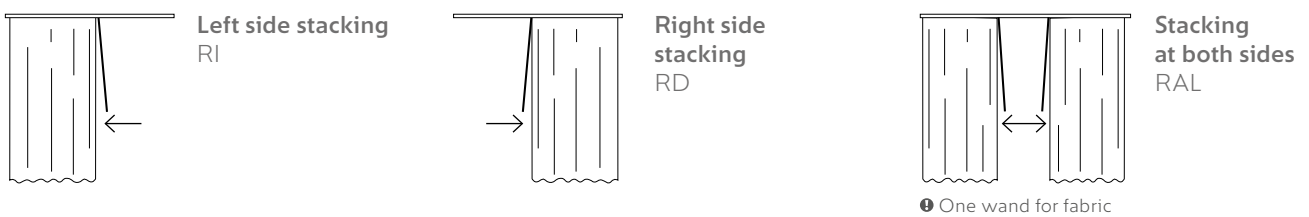

#### Cord and motor track

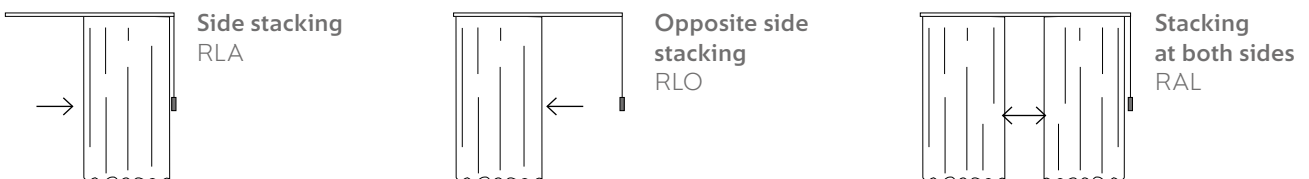

# DRAPERIES RANGE

## TECHNICAL DATA

### Curved track limits for optimum operation

The minimum radius of curves to ensure optimum displacement is r550 mm.  
The following diagrams show examples of this radius.

**Each curve must be preceded on both sides by 500 mm of straight track.**

**The radius between two curves must be at least 650 mm.**

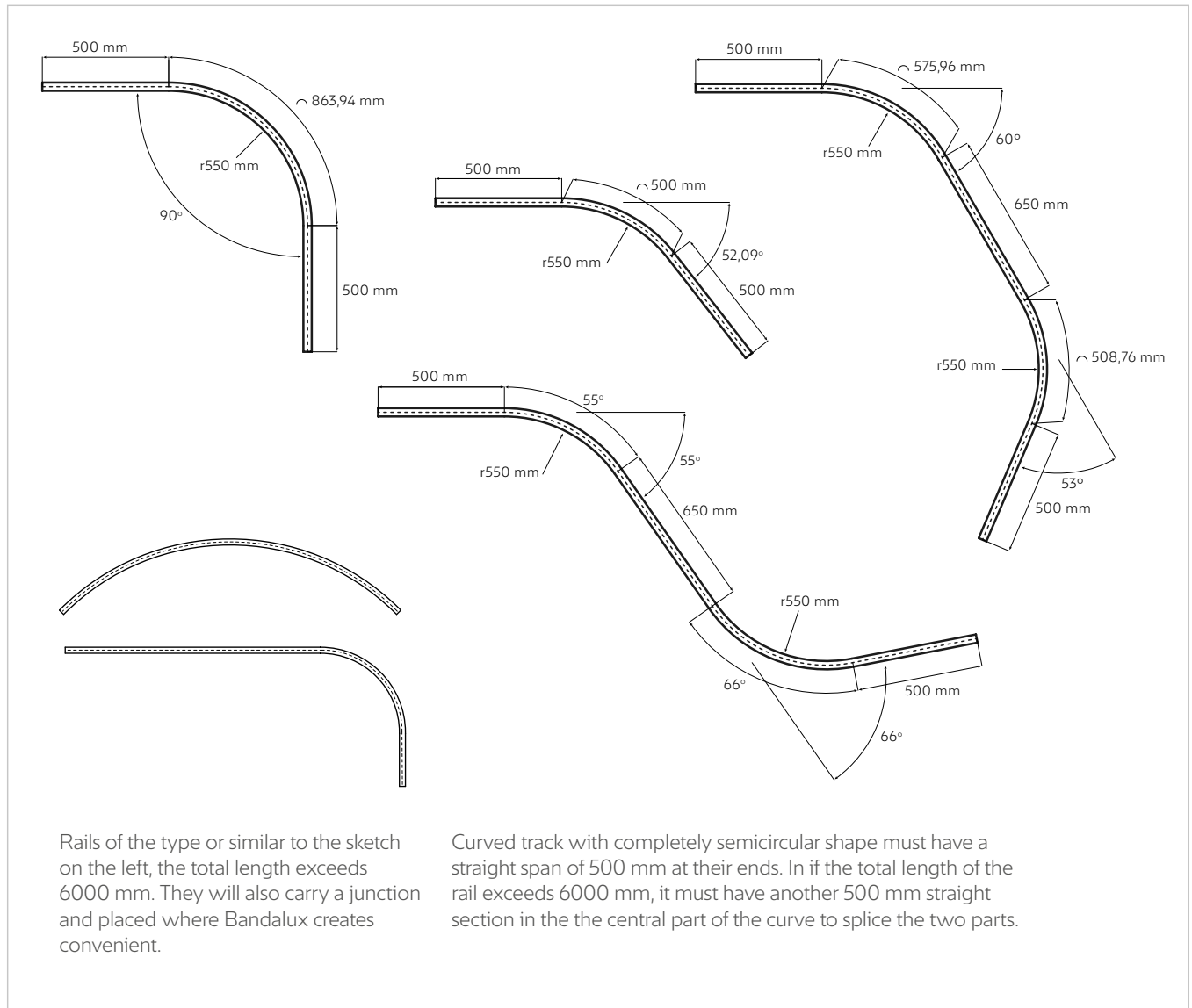

❗ To make this blind, it is essential to enclose an actual-size sketch, specifying whether the drawing is seen from above or below the rail.

# DRAPERIES RANGE

## TECHNICAL DATA

### Controls height

#### CORD OPERATING SYSTEM WITH CHILD SAFETY SYSTEM

The Child Safety piece must be positioned at a minimum height of 1500 mm from the floor.

To calculate the controls height (hm) see the following diagram:

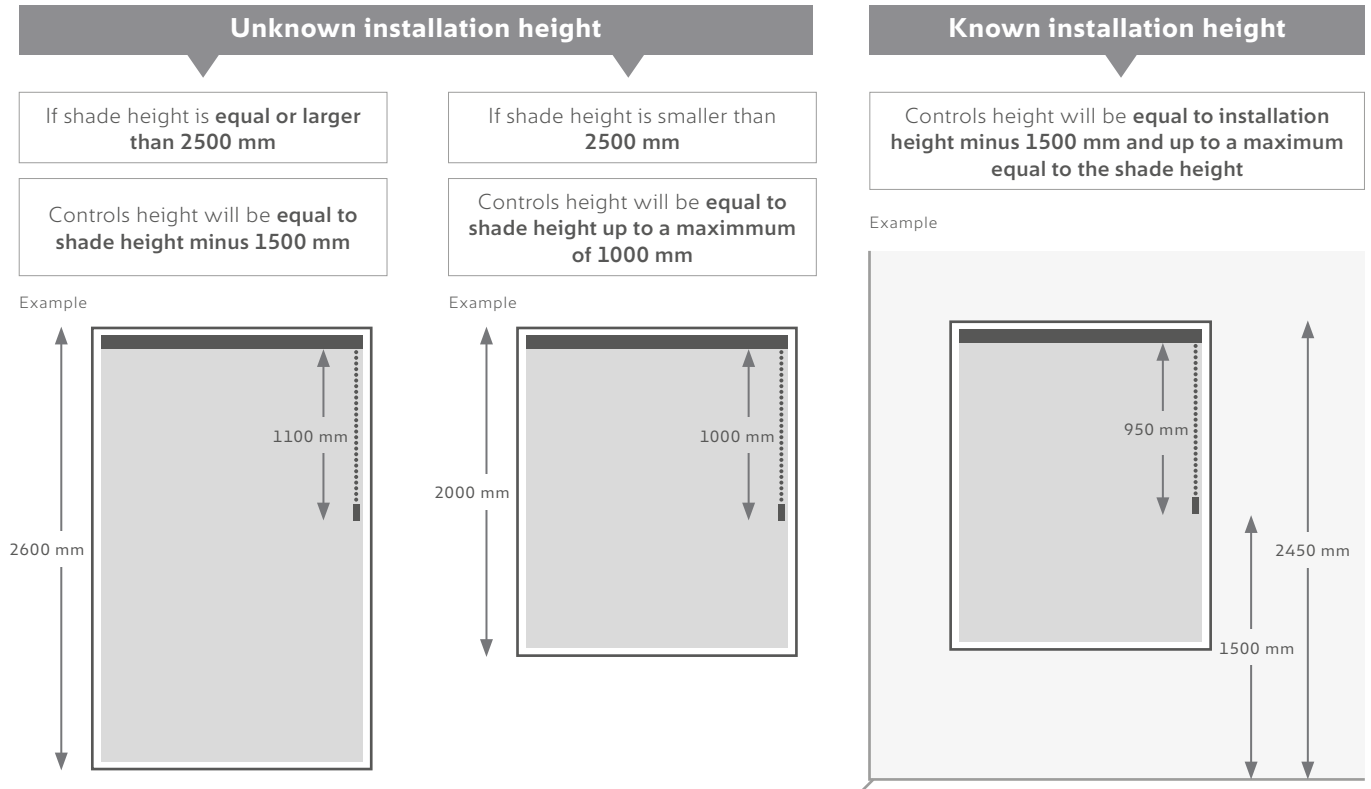

❗ The controls height will always be measured from the uppermost section of the shade (upper end of the track), to the lower part of the cord tensioner.

#### CORD OPERATING SYSTEM WITHOUT CHILD SAFETY SYSTEM

If Child Safety/Safekids is waived, the control height will be:

Shade height (H)	Commands height (hc)
510 - 2200 mm	Shade height - 100 mm
> 2200 mm	Shade height - 1000 mm



# DRAPERIES RANGE

## TECHNICAL DATA

### Cross-sectional drawing and track and bracket heights

**Elementos track, wall**

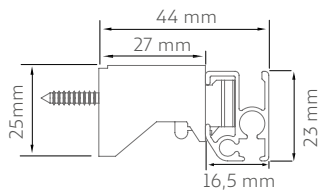

**Elementos track, ceiling**

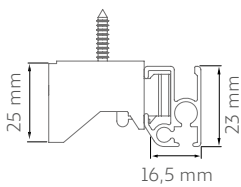

**Square track, wall**

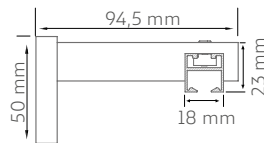

**Square track, double**

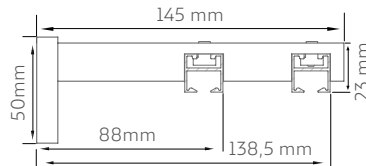

**Square track, ceiling**

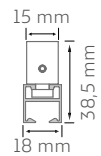

**Dike track, façade**

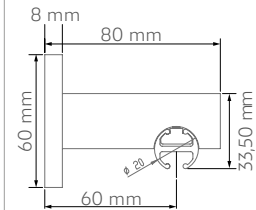

**Dike track, double**

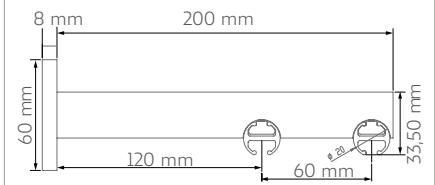

**Ripple Fold, cord wall**

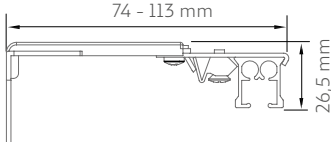

**Ripple Fold, cord ceiling**

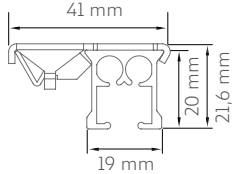

**Ripple Fold, wand wall**

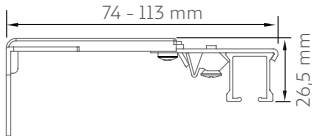

**Ripple Fold, wand ceiling**

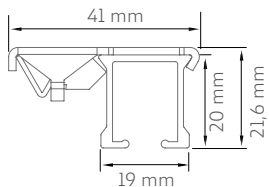

**Urban track, wall**

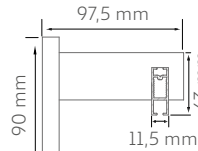

**Urban track, double**

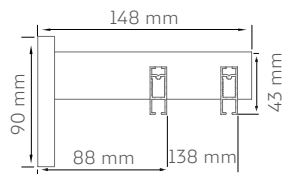

**Urban track, ceiling**

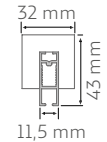

**Kali track, wall**

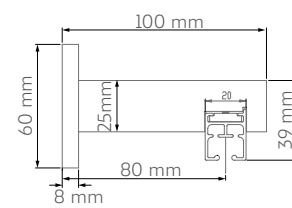

**Kali track, double**

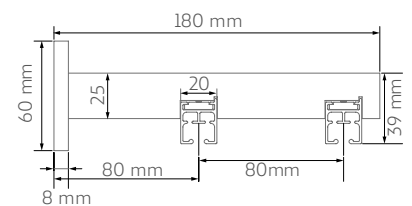

**Kali track, ceiling**

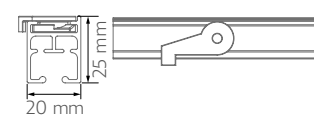

# DRAPERIES RANGE

## TECHNICAL DATA

**Elpis track, double**

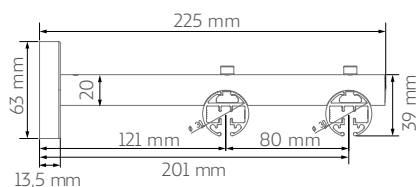

**Elpis track, wall**

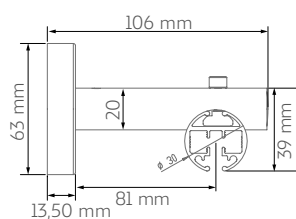

**Elpis track, ceiling**

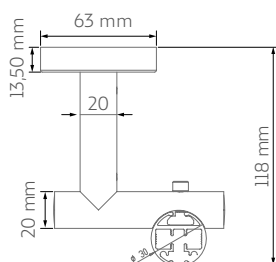

**Aeris track, wall**

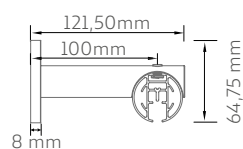

**Aeris track, double**

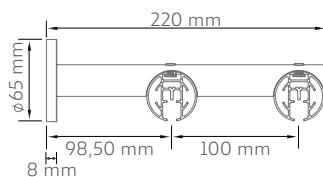

**Aeris track, ceiling**

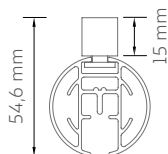

**Estrada track, ceiling  
XXL track, ceiling**

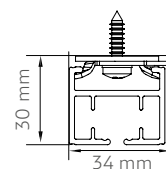

**Estrada track, motor**

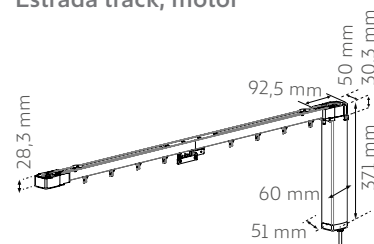

**XXL track**

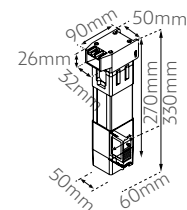

**Yuna track, wall**

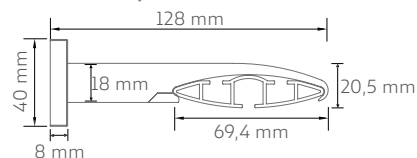

**Yuna track, ceiling**

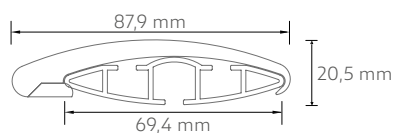

**Glydea track, rotary to ceiling**

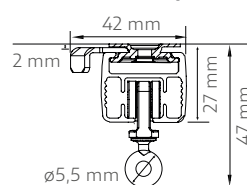

**Glydea track, ceiling**

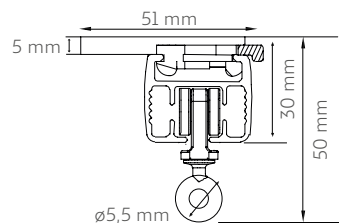

# DRAPERIES RANGE

## TECHNICAL DATA

### Motor-operated

Type	Model	Nm	r.p.m	Power (W)	Intensity (A)
Estrada track	230V/99W	2,0	86	99	0,45
Glydea track - 35 WT	230V	-	20 cm/s	60	0,26
Glydea track - 60 WT	230V	-	20 cm/s	120	0,52
Glydea track - 35 RTS	230V	-	20 cm/s	60	0,26
Glydea track - 60 RTS	230V	-	20 cm/s	120	0,52
XXL track	230V/45W	1,2	90	45	0,20

### Gap between the track and the fabric in Ripple Fold manufacture



ⓘ The height of the blind is equal to the height of the fabric.

Measurement "a" (mm)	Bar	Elementos track	Ripple Fold track	Square track	Urban track	Dike track	Kali track	Elpis track	Yuna track	Aeris track	Estrada / Glydea / XXL track
Grommets	0 mm	-	-	-	-	-	-	-	-	-	-
Flat Pleat	45 mm	0 mm	-	18 mm	33 mm	33 mm	27 mm	33 mm	23 mm	45 mm	0 mm
Table Pleat	45 mm	0 mm	-	18 mm	33 mm	33 mm	27 mm	33 mm	23 mm	45 mm	0 mm
Normal Pleat	45 mm	0 mm	-	18 mm	33 mm	33 mm	27 mm	33 mm	23 mm	45 mm	0 mm
Single Pleat	45 mm	-	-	18 mm	33 mm	33 mm	-	-	23 mm	-	-
V Pleat	45 mm	-	-	18 mm	33 mm	33 mm	-	-	23 mm	-	-
Double Pleat	45 mm	-	-	18 mm	33 mm	33 mm	-	-	23 mm	-	-
Triple Pleat	45 mm	-	-	18 mm	33 mm	33 mm	-	-	23 mm	-	-
Ripple Fold	-	-	25 mm	18 mm	-	-	27 mm	33 mm	23 mm	45 mm	35 mm

# DRAPERIES RANGE

## TECHNICAL DATA

### Retraction space according to blind width

#### URBAN AND SQUARE TRACKS

Measurements in mm

	RI-RD-LB1						RAL - LB2					
	1000	2000	3000	4000	5000	6000	1000	2000	3000	4000	5000	6000
Normal Pleat	180	360	540	720	900	1080	825	165	247,5	330	412,5	495
Flat Pleat	216	432	648	864	1080	1296	99	198	297	396	495	594
Table Pleat	216	432	648	864	1080	1296	99	198	297	396	495	594
Single Pleat	216	432	648	864	1080	1296	99	198	297	396	495	594
V Pleat	216	432	648	864	1080	1296	99	198	297	396	495	594
Double Pleat	216	432	648	864	1080	1296	99	198	297	396	495	594
Triple Pleat	216	432	648	864	1080	1296	99	198	297	396	495	594
Ripple Fold <sup>(1)</sup>	260	520	780	1040	1300	1560	130	260	390	520	650	780

<sup>(1)</sup> Not available for Urban track. / Approximate retraction space.

#### ELEMENTOS AND ELPIS TRACK

Measurements in mm

	RLA-RLO						RAL					
	1000	2000	3000	4000	5000	6000	1000	2000	3000	4000	5000	6000
Normal Pleat	380	560	740	920	1100	1280	282,5	365	447,5	530	612,5	695
Flat Pleat	416	632	848	1064	1280	1496	299	398	497	596	695	794
Table Pleat	416	632	848	1064	1280	1496	299	398	497	596	695	794
Ripple Fold <sup>(1)</sup>	460	720	980	1240	1500	1760	330	460	590	720	850	980

<sup>(1)</sup> Not available for Elementos track. / For manual operation of the Elementos track, subtract 70 mm from the retraction space. / Approximate retraction space.

#### ESTRADA, GLYDEA AND XXL RAILS WITH MOTOR

Measurements in mm

	RLA-RLO						RAL					
	1000	2000	3000	4000	5000	6000	1000	2000	3000	4000	5000	6000
Normal Pleat	440	620	800	980	1160	1340	342,5	425	507,5	590	672,5	755
Flat Pleat	476	692	908	1124	1340	1556	359	458	557	656	755	854
Table Pleat	476	692	908	1124	1340	1556	359	458	557	656	755	854
Ripple Fold <sup>(1)</sup>	520	780	1040	1300	1560	1820	390	520	650	780	910	1040

<sup>(1)</sup> Approximate retraction space.

# DRAPERIES RANGE

## TECHNICAL DATA

### YUNA TRACK

Measurements in mm

	RI-RD-LB1						RAL - LB2					
	1000	2000	3000	4000	5000	6000	1000	2000	3000	4000	5000	6000
Normal Pleat	200	380	560	740	920	1100	102,5	185	267,5	350	432,5	515
Flat Pleat	236	452	668	884	1100	1316	119	218	317	416	515	614
Table Pleat	236	452	668	884	1100	1316	119	218	317	416	515	614
Single Pleat	236	452	668	884	1100	1316	119	218	317	416	515	614
V Pleat	236	452	668	884	1100	1316	119	218	317	416	515	614
Double Pleat	236	452	668	884	1100	1316	119	218	317	416	515	614
Triple Pleat	236	452	668	884	1100	1316	119	218	317	416	515	614
Ripple Fold <sup>(1)</sup>	280	540	800	1060	1320	1580	150	280	410	540	670	800

<sup>(1)</sup> Approximate retraction space.

### KALI TRACK

Measurements in mm

	RLA-RLO						RAL					
	1000	2000	3000	4000	5000	6000	1000	2000	3000	4000	5000	6000
Normal Pleat	370	550	730	910	1090	1270	272,5	355	437,5	520	602,5	685
Flat Pleat	406	622	838	1054	1270	1486	289	388	487	586	685	784
Table Pleat	406	622	838	1054	1270	1486	289	388	487	586	685	784
Ripple Fold <sup>(1)</sup>	450	710	970	1230	1490	1750	320	450	580	710	840	970

<sup>(1)</sup> Approximate retraction space.

### AERIS TRACK

Measurements in mm

	RLA-RLO						RAL					
	1000	2000	3000	4000	5000	6000	1000	2000	3000	4000	5000	6000
Normal Pleat	330	510	690	870	1050	1230	232,5	315	397,5	480	562,5	645
Flat Pleat	366	582	798	1014	1230	1446	249	348	447	546	645	744
Table Pleat	366	582	798	1014	1230	1446	249	348	447	546	645	744
Ripple Fold <sup>(1)</sup>	410	670	930	1190	1450	1710	280	410	540	670	800	930

### RIPPLE FOLD TRACK

Measurements in mm

	RLA-RLO						RAL					
	1000	2000	3000	4000	5000	6000	1000	2000	3000	4000	5000	6000
Ripple Fold <sup>(1)</sup>	455	715	975	1235	1495	1755	325	455	585	715	845	975

<sup>(1)</sup> For wand operation subtract 50 mm from the retraction space. / For manual operation subtract 70 mm from the retraction space. / Espace de collecte approximatif.

# GAMA TRADICIONALES

## DATOS TÉCNICOS

### BAR

Measurements in mm

	RLA-RLO						RAL					
	1000	2000	3000	4000	5000	6000	1000	2000	3000	4000	5000	6000
Grommets	400	800	1200	1600	2000	2400	200	400	600	800	1000	1200
Normal Pleat	300	600	900	1200	1500	1800	150	300	450	600	750	900
Flat Pleat	350	700	1050	1400	1750	2100	175	350	525	700	875	1050
Table Pleat	350	700	1050	1400	1750	2100	175	350	525	700	875	1050
Single Pleat	350	700	1050	1400	1750	2100	175	350	525	700	875	1050
V Pleat	350	700	1050	1400	1750	2100	175	350	525	700	875	1050
Double Pleat	350	700	1050	1400	1750	2100	175	350	525	700	875	1050
Triple Pleat	350	700	1050	1400	1750	2100	175	350	525	700	875	1050

ⓘ Approximate retraction space

## Trazer technical data

### MOUNT PLATE PERSONALIZATION

	Standard	Without mount plate	Minimum	Maximum
Elementos / Estrada / Glydea / XXL tracks	105 mm	0 mm	100 mm	190 mm
Ripple Fold track	150 mm	0 mm	150 mm	190 mm

### PROJECTION PERSONALIZATION

	Projection width
Recommended size Trazer 73	95 mm
Recommended size Trazer 100	125 mm
Without projection	0 mm
Minimum	50 mm
Maximum	150 mm

### NUMBER OF BRACKETS ACCORDING TO SHADE WIDTH

Elementos / Estrada / Ripple Fold / Glydea / XXL tracks	Nº brackets
$W < 1250$ mm	2
$1250 \text{ mm} \leq W < 2000$ mm	3
$2000 \text{ mm} \leq W < 3000$ mm	4
$3000 \text{ mm} \leq W < 4000$ mm	5
$4000 \text{ mm} \leq W < 5000$ mm	6
$5000 \text{ mm} \leq W$	7

### SPACE BETWEEN THE MOUNT PLATE AND THE FABRIC

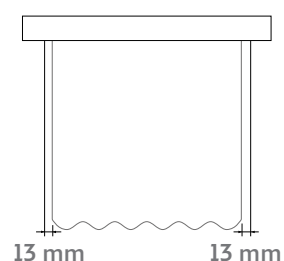

### TYPE OF INSTALLATION

#### WALL



#### CEILING

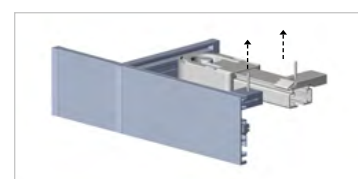

ⓘ For wall installation, the size of the mount plate must be 10 mm larger than the size of the bracket.



**BANDALUX**